

STATICWORX ESD BOLT CHAIRS

NEW GENERATION WORKPLACE CHAIRS



BOLT ESD SEATING

Bolt cuts a fine figure in ESD-protected workspaces, such as electronics manufacturing, clean rooms and labs, as well as critical call centers and other end-user spaces. This is due to its outstanding industrial-ergonomic design, combined with a wide choice of upholstery and optional features.

- Low maintenance
- Washable
- Robust
- Easy to repair
- Tough, durable
- 10 year limited warranty
- Economical
- Adaptable
- Flexible
- Conforms to body shape
- Ergonomic
- Easily configurable
- Upholstery easy to change
- Safe
- Sustainable
- Meets ANSI/ESD S20.20

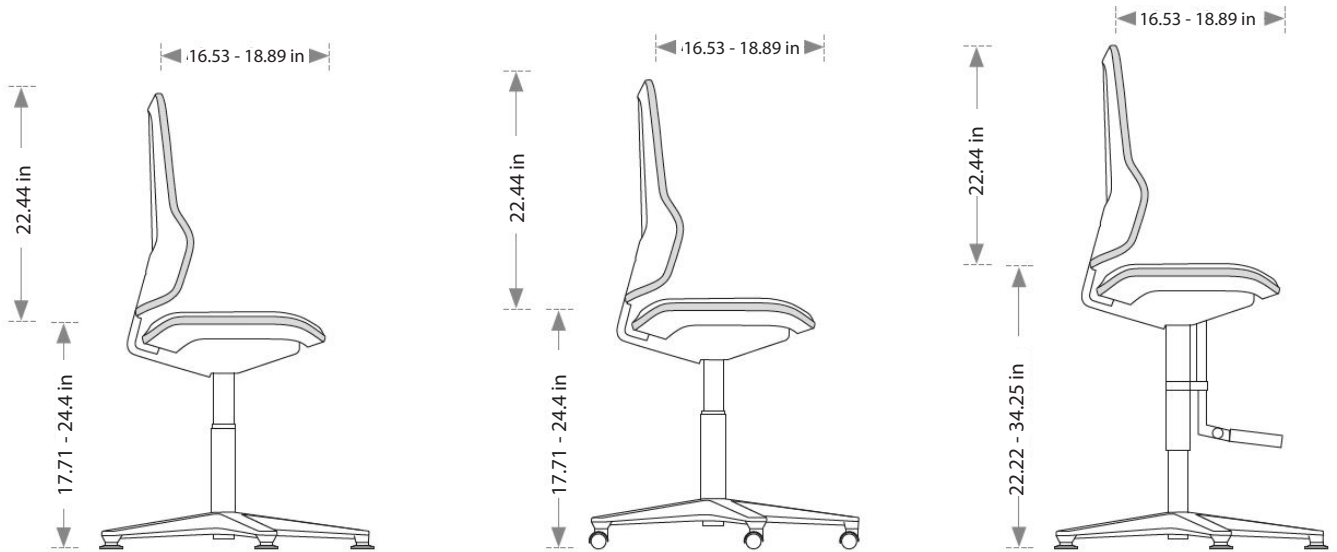

SEAT HEIGHT

17.71 - 24.40 in

17.71 - 24.40 in

22.22 - 34.25 in

SEAT DEPTH

16.53 - 18.89 in

16.54 - 18.89 in

16.53 - 18.89 in



UPHOLSTERY

ESD Fabric

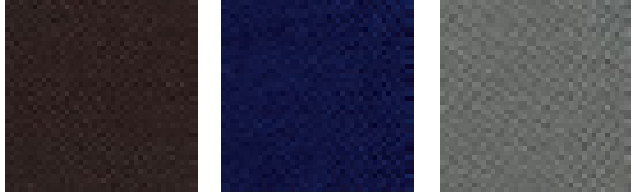

ESD Synthetic Leather

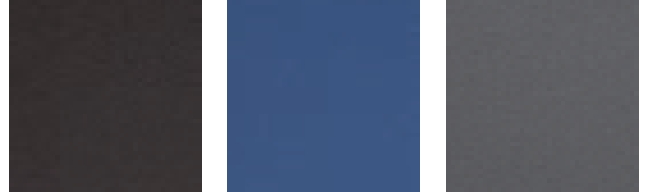

Integral Foam

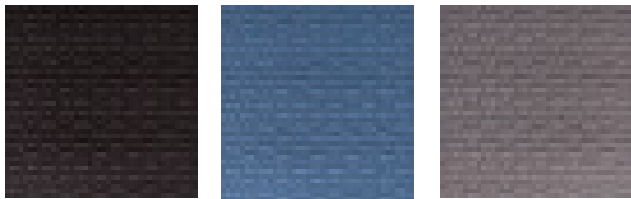

Ultratec

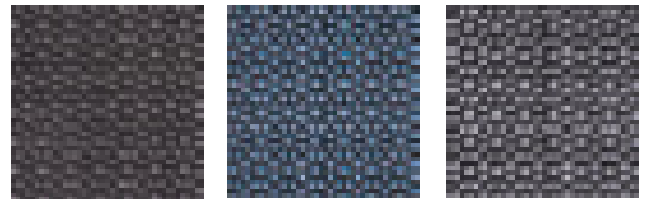

FLEX STRIP



Cadmium orange (standard)



Neon green



Slate grey



Electric blue

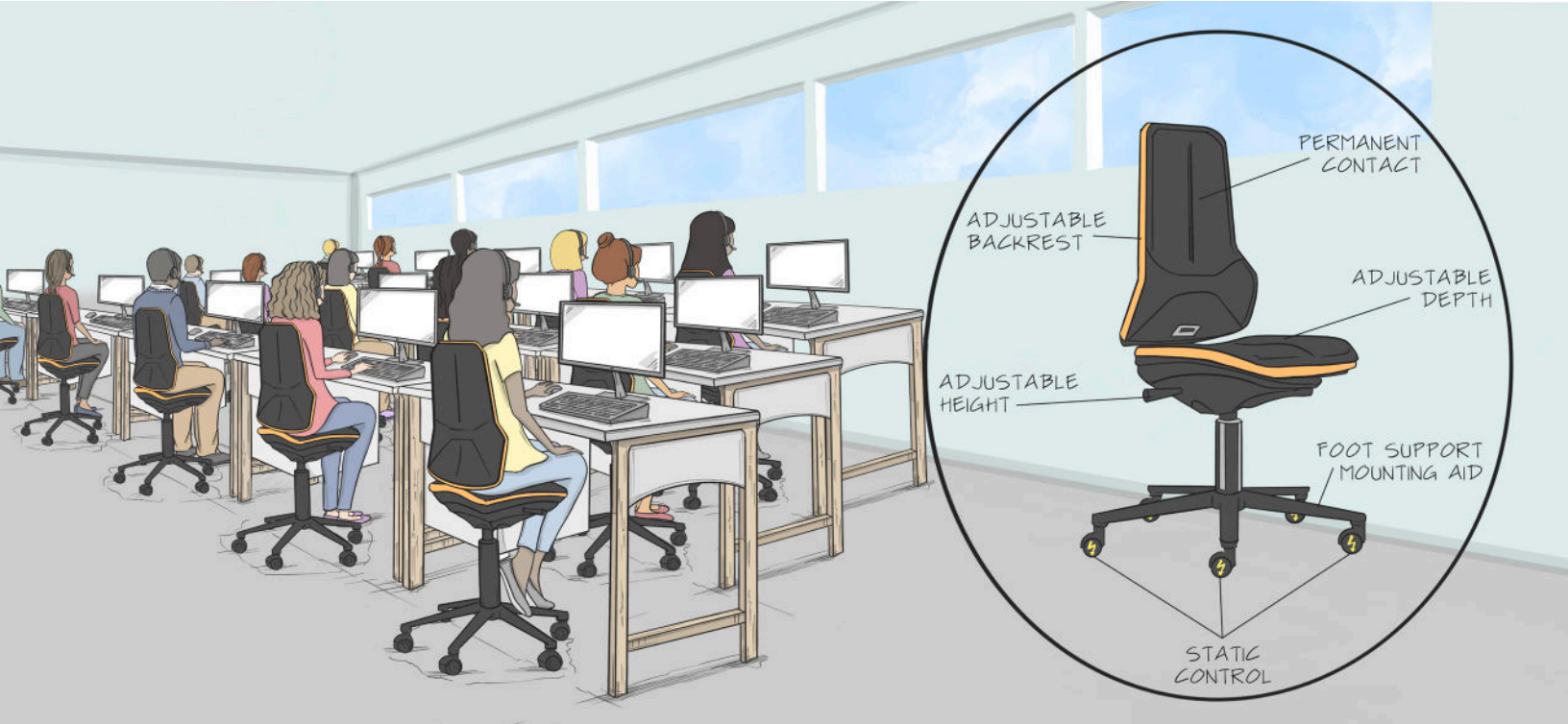

FEATURES	Meets ANSI/ESD S20.20 Complies with STM12.1	Meets ANSI/ESD S20.20 Complies with STM12.1	Meets ANSI/ESD S20.20 Complies with STM12.1
	<p>Ergonomic package Adjustable seat height Adjustable seat incline Adjustable seat depth Adjustable backrest height</p>	<p>Ergonomic package Adjustable seat height Adjustable seat incline Adjustable seat depth Adjustable backrest height</p>	<p>Ergonomic package Adjustable seat height Adjustable seat incline Adjustable seat depth Adjustable backrest height</p>
	<p>Aluminum base Black Optional: aluminum polished</p>	<p>Aluminum base Black Optional: aluminum polished</p>	<p>Aluminum base Black Optional: aluminum polished</p>
	<p>Backrest shell Black, conductive</p>	<p>Backrest shell Black, conductive</p>	<p>Backrest shell Black, conductive</p>
		<p>Castors for hard floors</p>	<p>Height-adjustable mounting aid</p>



ACCESSORIES & OPTIONS

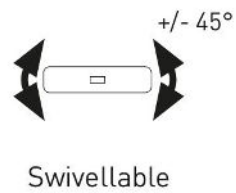
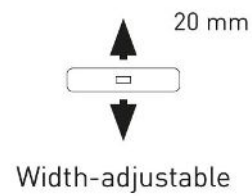
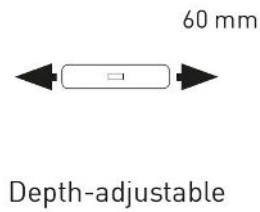
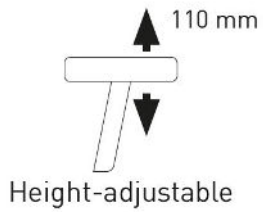

Bolt Foot Ring

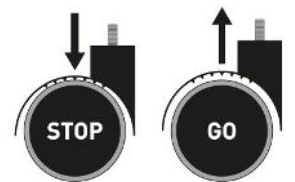

Stop & Go Castors